

## TE222LED, 2-LIGHT TRIMLESS LED MULTIPLE RECESS

### PRODUCT DETAILS

No.	:	TE222LED-40-4-01
Product Color	:	BLACK
Length	:	12.25"
Width	:	6.25"
Height	:	7"



### TECHNICAL DETAILS

Driver	:	Inventronics 35W Current Driver
Location	:	DRY
Approval	:	
Beam Angle	:	40
Cut Hole Length	:	12.5"
Cut Hole Width	:	6.5"

### Options Available

ITEM NO.	FINISH	SHADE
TE222LED-40-4-01	BLACK	
TE222LED-40-4-02	WHITE	

### LIGHT SOURCE DETAILS

Number of Bulbs	:	2
Light Source	:	LED
Light Source Type	:	LED
Input Voltage	:	120V
Socket Type	:	LED
Wattage	:	26W
Total Lumen	:	2500lm
Kelvin	:	4000K
CRI	:	90
Bulb Included	:	Yes
Dimmable	:	Yes

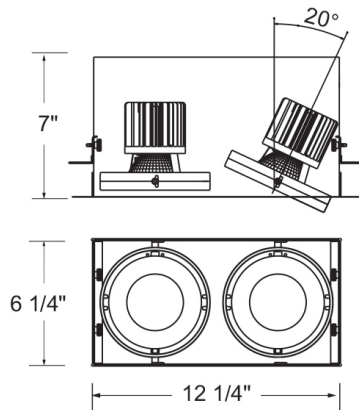

### PROJECT INFORMATION

Job Name:  Date:  Type:

Comments: