

WARNINGS



RISK OF FIRE, ELECTRICAL SHOCK, CUTS OR OTHER CASUALTY HAZARDS

Installation and maintenance of this product must be performed by a qualified electrician. This product must be installed in accordance with the applicable installation code by a person familiar with the construction and operation of the product and hazards involved.

RISK OF FIRE AND ELECTRIC SHOCK

Make certain power is OFF before starting installation or attempting any maintenance. Disconnect power at fuse or circuit breaker.

RISK OF FIRE

Refer to product label for specific minimum supply conductor requirements.

RISK OF BURN

Disconnect power and allow fixture to cool before handling or servicing.

RISK OF PERSONAL INJURY

Fixture may become damaged and/or unstable if not installed properly.

DISCLAIMER OF LIABILITY: CSC LED assumes no liability for damages or losses of any kind that may arise from the improper, careless, or negligent installation, handling or use of this product.

NOTICE: Green ground wire is provided in proper location. Do not relocate.

SAFETY: This fixture must be wired in accordance with the National Electrical Code and applicable local codes and ordinances. Proper grounding is required to ensure personal safety. Carefully observe grounding procedure under installation section.

APPLICATIONS: This lighting fixture is designed for indoor lighting applications, and should not be used in an area with limited ventilation or inside high ambient temperature enclosures. It must be stored in a dry location prior to installation.

ATTENTION RECEIVING DEPARTMENT: Note actual fixture description of any shortage or noticeable damage on delivery receipt. File claim for common carrier (LTL) directly with carrier. Claims for concealed damage must be filed within 15 days of delivery. All damaged material, complete with original packaging must be retained.

DIMENSIONAL DRAWING

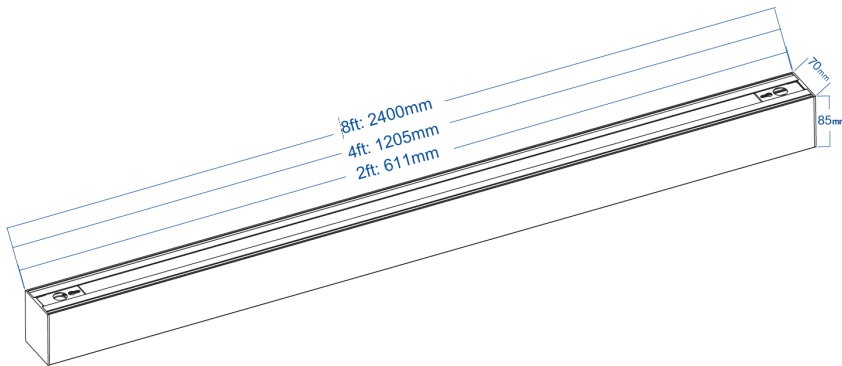

WIRING DIAGRAM

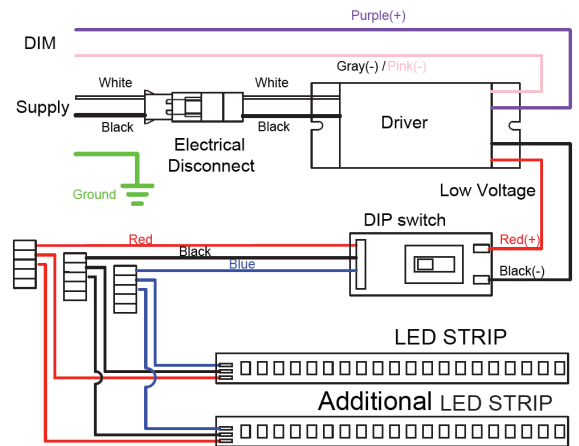

CCT SELECTION

1. Remove the lens with the tool provided (Fig. 1.1)
2. Select the desired colour temperature settings (3000K/3500K/4000K) using the switch, and reattach the lens (Fig. 1.2)

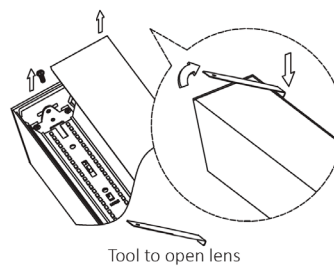

Fig. 1.1

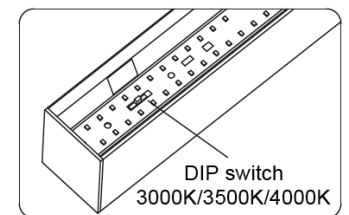

Fig. 1.2

SURFACE MOUNT

(FOR INSTALLATION WITH DIRECT LUMINAIRES)

1. Remove the lens with the tool provided and then remove the LED reflector strip. (Fig. 2.1 & 2.2)
2. Mount the luminaire with screws and anchors (not included) through the pre-drilled holes on the top of the luminaire. (Fig. 2.3 & 2.4)
3. Select CCT (3000K/3500K/4000K) and reattach the LED reflector strip and lens (Fig. 2.5 & 2.6)

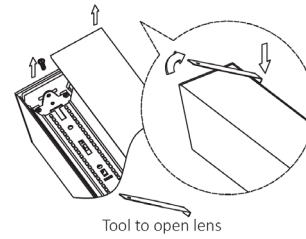

Fig. 2.1

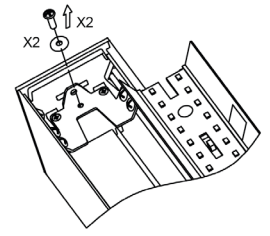

Fig. 2.2

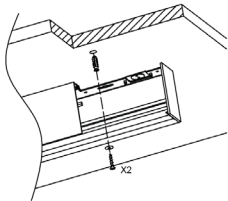
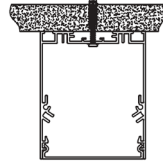

Fig. 2.3



Drywall
Fig. 2.4

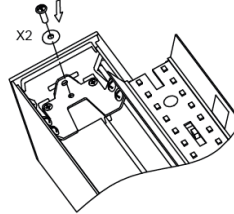

Fig. 2.5

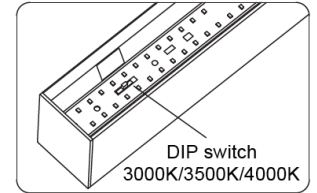

Fig. 2.6

SUSPENDED MOUNT

(FOR INSTALLATION OF DIRECT LUMINAIRES TO CEILING)

NOTE: Refer to the final page for recommended mounting points based on various configurations utilizing Backlit Connectors.

1. Remove lens and LED reflector strip (see *Surface Mount instructions*). (Fig. 2.1 & 2.2)
2. Fig 3.1 gives you an overview of the suspension kit. Detach the aircraft cable from the ceiling bracket and install the ceiling bracket to the ceiling with the provided anchors and washers. (Fig. 3.2) The distance between the center of the canopy is given in Fig 3.3.
3. Secure the aircraft cable grippers to the luminaire with the screws and washers provided. (Fig. 3.4)
4. Remove the power cord knockout. (Fig. 3.5) Slip the power cord through the power cord knock out and canopy using the strain relief provided. (Fig. 3.6)
5. Select CCT (3000K/3500K/4000K) and reattach LED reflector strip and lens. (Fig. 2.5 & Fig. 2.6)
6. Connect the power cord to the ceiling power feed (refer to wiring diagram). (Fig. 3.7)
7. Affix the gripper through the canopy to the ceiling bracket. Adjust the aircraft cable to achieve desired mounting height. Cut excessive cable if necessary.
8. Secure the canopy on the sides with the provided screws.

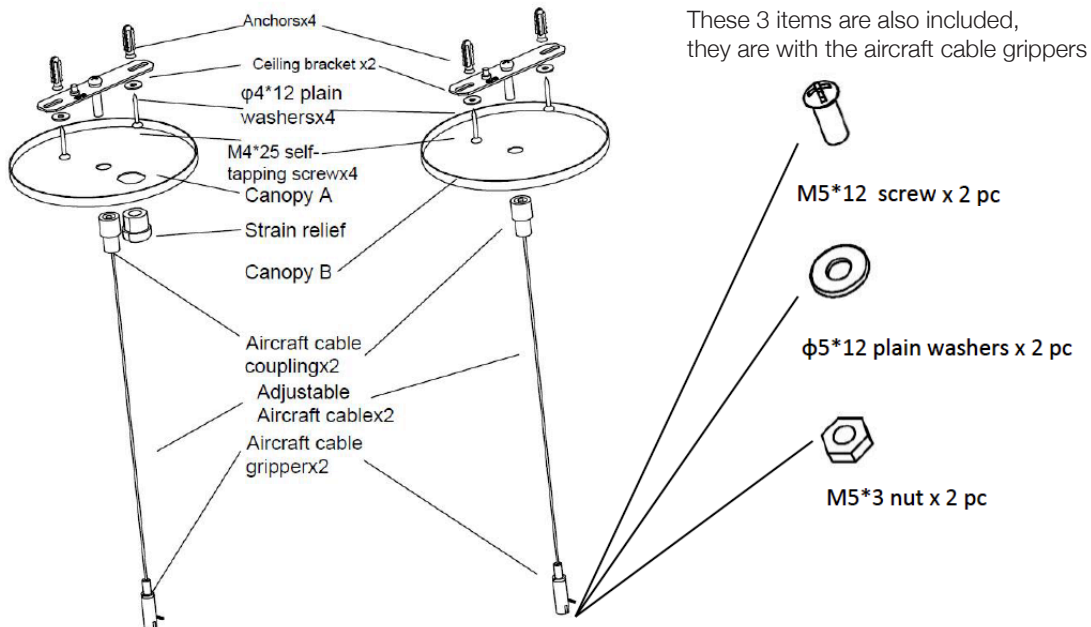

Fig. 3.1

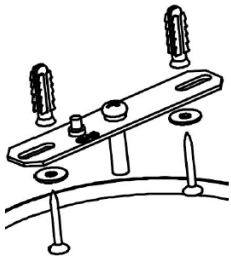

Fig. 3.2

	2ft	3ft	4ft	5ft	6ft	8ft
L	24.06" 611mm	35.75" 908mm	47.48" 1206mm	59.29" 1506mm	71.10" 1806mm	94.53" 2401mm
L1	17.13" 435mm	28.82" 732mm	40.55" 1030mm	52.36" 1330mm	64.17" 1630mm	87.60" 2225mm

Fig. 3.3

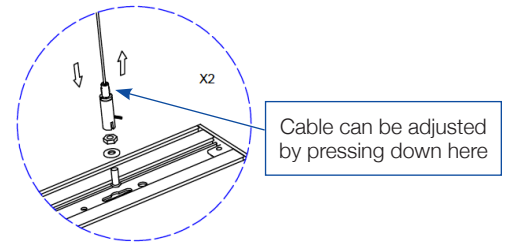

Fig. 3.4

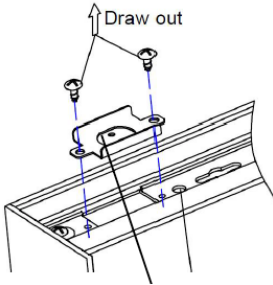

Fig. 3.5

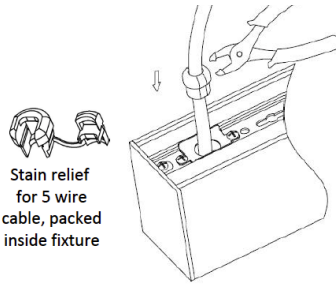

Fig. 3.6

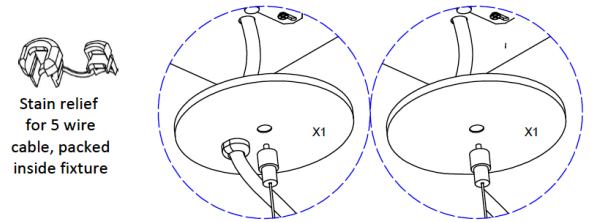

Fig. 3.7

SUSPENDED MOUNT

(FOR INSTALLATION OF DIRECT/INDIRECT LUMINAIRE TO CEILING)

NOTE: Refer to the final page for recommended mounting points based on various configurations utilizing Backlit Connectors.

1. Remove lens and LED reflector strip (see *Surface Mount instructions*). (Fig. 2.1 & 2.2)
2. Remove the end cap and side plate. (Fig. 4.1)
3. Detach the aircraft cable from the ceiling bracket and install the ceiling bracket to the ceiling with the provided anchors and washers (Fig. 3.2). The distance between the center of the canopy is given in Fig 3.3.
4. Secure the aircraft cable grippers to the luminaire with the screws and washers provided onto the access plate and slide it back in. (**Warning:** only tighten the screws after removing the access plate from the luminaire housing). (Fig. 4.2)
5. Slip the power cord through the access plate and canopy. (Fig. 3.6)
6. Put the end cap back in place.
7. Select CCT (3000K/3500K/4000K) and reattach the LED reflector strip and lens. (Fig. 2.5 & 2.6)
8. Connect the power cord to the ceiling power feed using the included strain relief (refer to wiring diagram). (Fig. 3.7)
9. Affix the gripper through the canopy to the ceiling bracket. Adjust the aircraft cable to achieve desired mounting height. Cut excessive cable if necessary.
10. Secure the canopy on the sides with the provided screws.

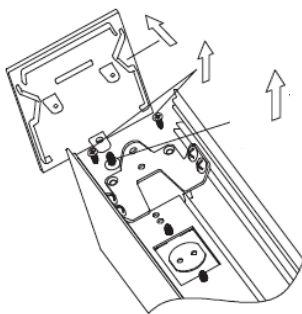

Fig. 4.1

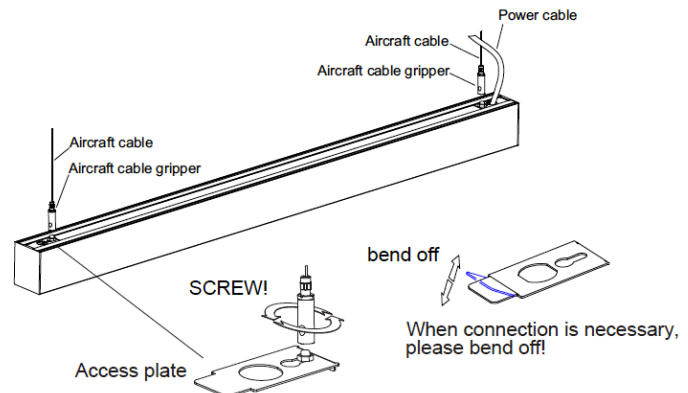

Fig. 4.2

SUSPENDED MOUNT

(FOR INSTALLATION OF DIRECT AND DIRECT/INDIRECT LUMINAIRES TO T-GRID BAR)

NOTE: Refer to the final page for recommended mounting points based on various configurations utilizing Backlit Connectors.

1. Remove lens and LED reflector strip (see *Surface Mount Instructions*). (Fig. 2.1 & 2.2)
2. Detach both sides of the bracket, press the end of the bracket down, and push the clip. (Fig. 5.1)
3. Put the screws through the hole at the bottom of the bracket. (Fig. 5.2)
4. Install the brackets on the T-Grid bar. (Fig. 5.3)
5. Push the snap-clip down to lock the brackets together on the T-Grid bar. (Fig. 5.4)

6. Fix the canopy of the suspension kit to the T-Bar mounting bracket. (Fig. 5.5)
7. Follow the instructions given in the suspended mount (for installation to ceiling) to complete installation. Fig. 5.7 gives you an overview of the installation.

NOTE: You will need the suspension kit to install the luminaire onto the T-Grid bar. If you are using the connectors in your design layout, please use the bracket (Fig. 5.6) in the suspension kit package for the installation, it will give you more flexibility in your installation.

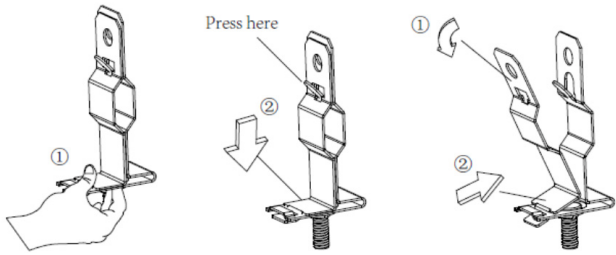

Fig. 5.1

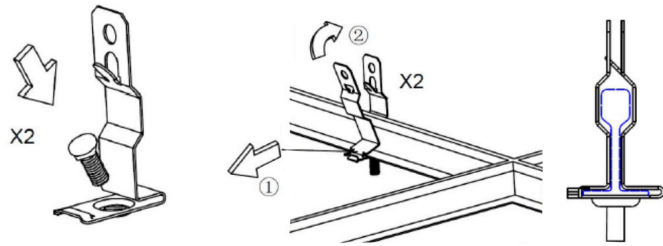

Fig. 5.2

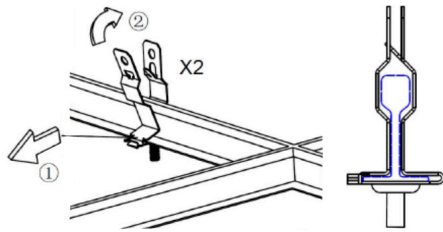

Fig. 5.3

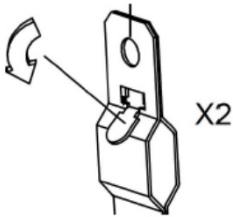

Fig. 5.4

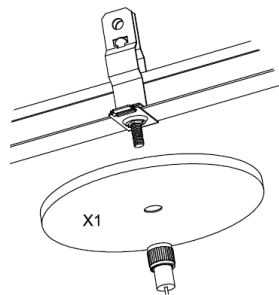

Fig. 5.5

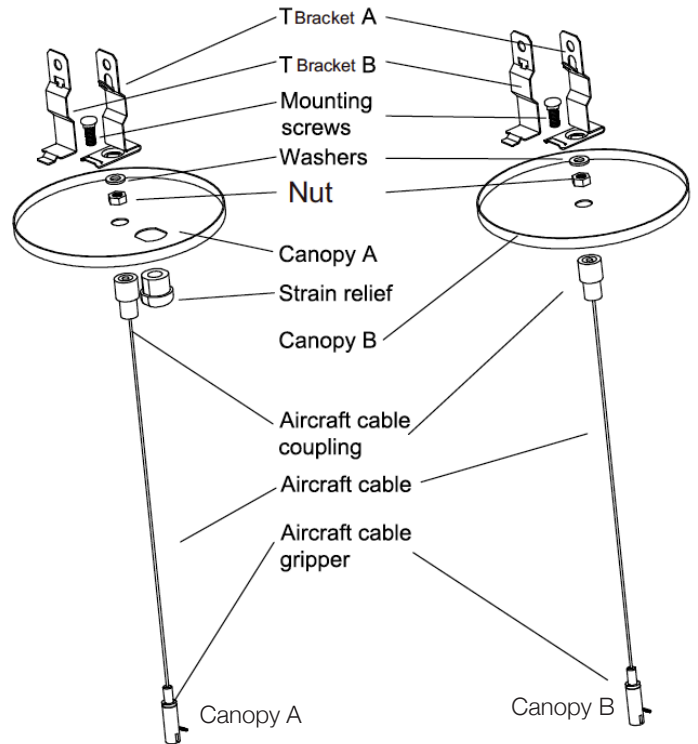

Fig. 5.7

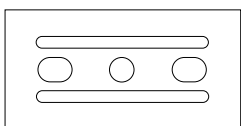

Fig. 5.6

CONTINUOUS ROW MOUNT AND CORNER CONNECTORS

NOTE: All luminaires and corner pieces are marked with an **A** on one end and a **B** on the other end.
In all cases **A**'s must be connected to **B**'s

1. Remove lens, LED reflector strip, and end cap.
(Fig. 6.1 - Fig. 6.3)
2. Insert the connection kit on the end of the luminaire. Connect it with the supplied screws through the second hole on the back.
(Fig. 6.4)
3. Connect the electrical wires (refer to the wiring diagram), slide the luminaires and corner connectors together (A to B). Join the connection kit, centering it between the luminaires and corner connectors.
(Fig 6.5 & 6.6)
4. Reattach the LED reflector strips and put the remaining screw in place (Fig. 6.7). Screw them back onto the plates.
5. Screw the end plates from the hole on plate A (flat top) to the hole on plate B (round top). (Fig. 6.8 & 6.9)
6. Select CCT (3000K/3500K/4000K) (Fig. 1.2)
7. Put the lens back in place. Adjust the lens to cover the potential gap in the middle.
NOTE: If you are planning to install this on a T-Bar with suspension, please use the clip in the suspension kit package for the installation (Fig. 6.10), it will give you more flexibility in your installation. The line wires used on this luminaire are 18 AWG (Fig. 6.11). Please refer to your local electrical code to determine the maximum number of luminaires allowed on a power line.

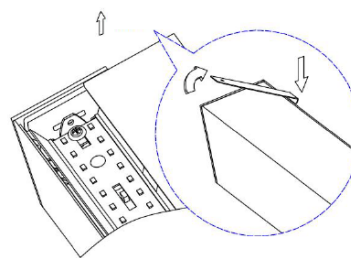
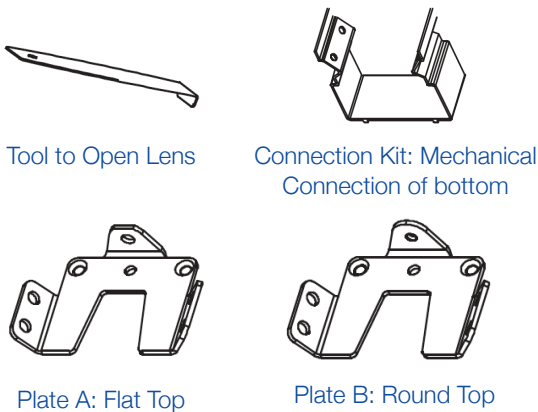

Fig. 6.1

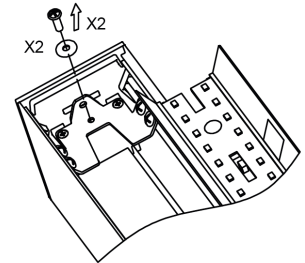

Fig. 6.2

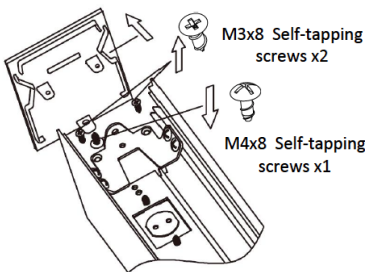

Fig. 6.3

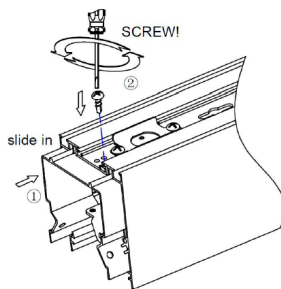

Fig. 6.4

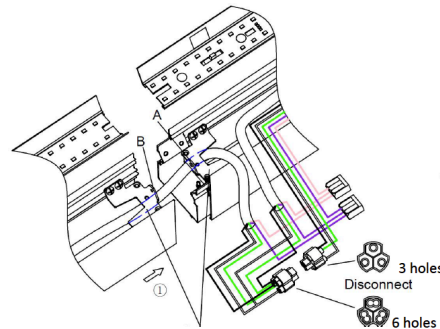

Fig. 6.5

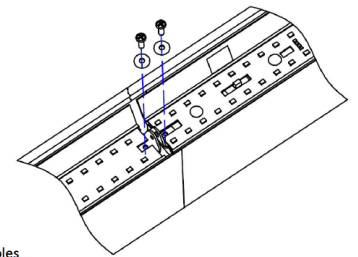

Fig. 6.6

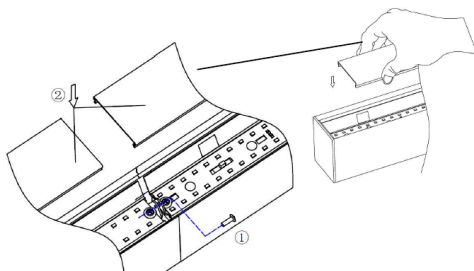

Fig. 6.7

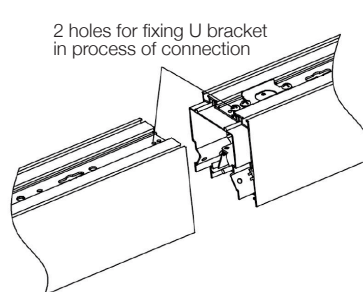

Fig. 6.8

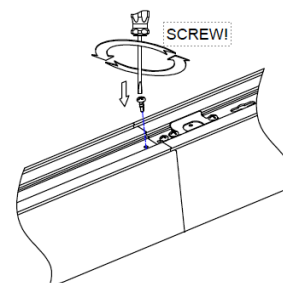

Fig. 6.9

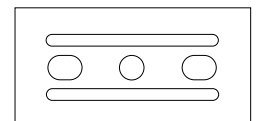
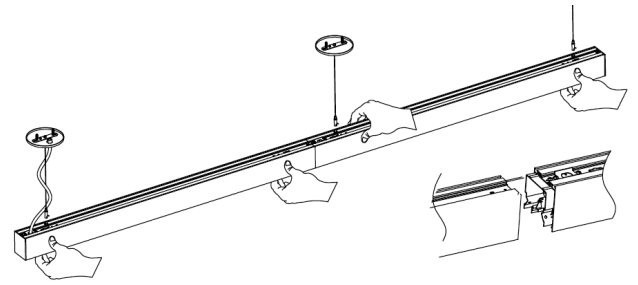

Fig. 6.10

# of Fixtures in a Row	Min. Required Mounting Points
2	3
4	5
6	7



<p>Note: Since 18 AWG wires are used in these luminaires, the max current allowable is 6A. Please refer to your local electrical code to determine the maximum luminaire allowed on a power line.</p>	AL2	0.17A
	AL4	0.43A
	AL8	0.85A

Fig. 6.11

WALL MOUNT

1. Remove lens and LED reflector strip. (Fig. 7.1)
2. Secure wall mount bracket to the wall. (Fig. 7.2)
NOTE: For distance of the holes, refer to Fig 7.3.
3. Secure wall mount bracket to the luminaire. Holes will need to be drilled in the luminaire housing to accomplish this. (Fig 7.4)
NOTE: A template is included on the last page for your reference.
4. Run cable through the hole on the wall mount bracket and luminaire (refer to the wiring diagram). The LED reflector strip and lens may now be reinstalled.
5. Hang the luminaire on the wall mount bracket. (Fig. 7.5)
6. Secure the two halves of the wall mount bracket together with screws. (Fig. 7.6)

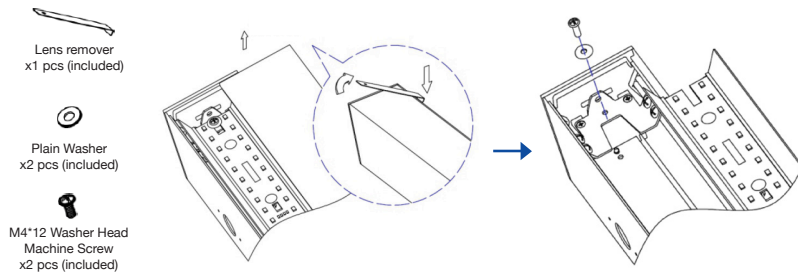

Fig. 7.1

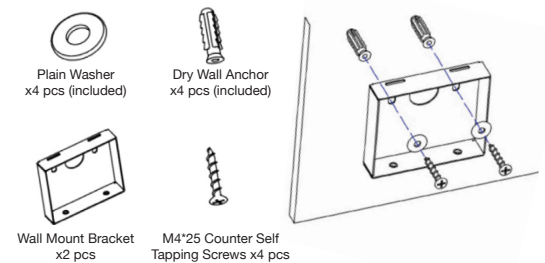

Fig. 7.2

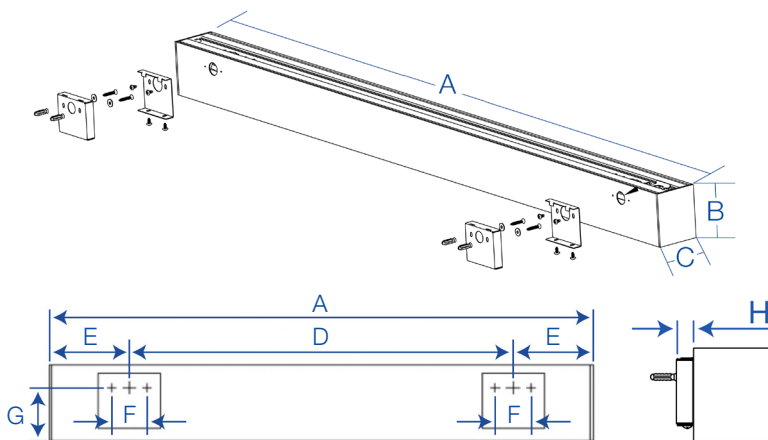

Fig. 7.3

(in inches)	2ft	4ft	8ft
A	24.06	47.48	94.53
B	3.3	3.3	3.3
C	2.8	2.8	2.8
D	16.73	40.16	87.20
E		3.66	
F		1.57	
G		2.36	
H		0.63	

Wall Mount
Bracket x2 pcs

M4*8 Counter Self
Tapping Screws
x4 pcs

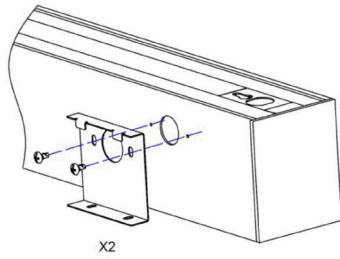

Fig. 7.4

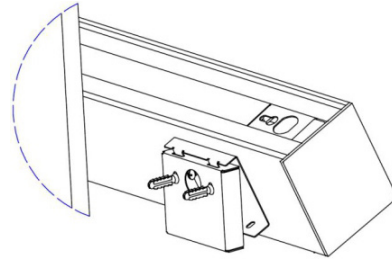
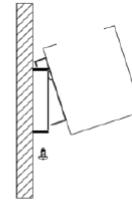
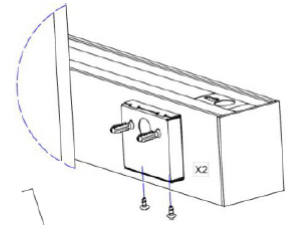

Fig. 7.5

M4*8 x4pcs
(included in parts bag)



Side View

Fig. 7.6

NOTE: For continuous row mounting, install connection plates and screws to connect luminaires as per continuous row mounting section "CONTINUOUS ROW MOUNT AND CORNER CONNECTORS". After which, follow the steps shown above to install the wall mount brackets. (Refer to the dimensions below for distance of holes between two luminaires)

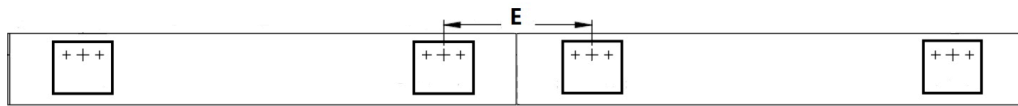

E: 180 mm (for 2FT+2FT, 2FT+4FT, and 4FT+4FT)

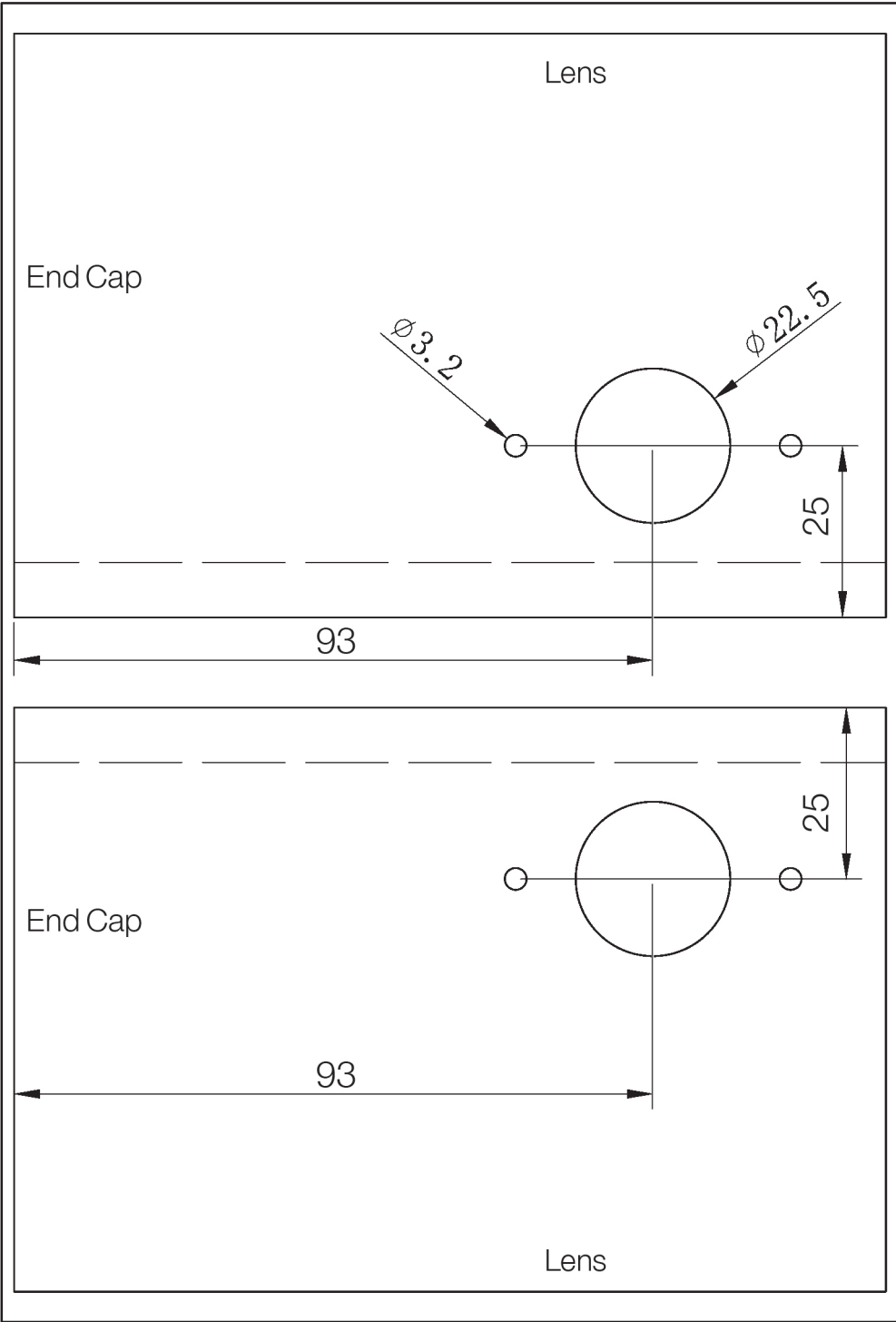

RECESSED KIT MOUNT

(FOR INSTALLATION WITH DIRECT LUMINAIRES AND NOT APPLICABLE FOR CONTINUOUS ROW MOUNT)

1. Remove the lens and LED reflector strip. (Fig. 8.1)
2. Cut a rectangular hole in the mounting surface. (Fig. 8.2)
3. Install the flange bars to the housing with the M4x8 self-drilling screws that are provided in the kit. (Fig. 8.3)
4. Insert the M4x50 screws provided through the hole shown in Fig 8.4, the screw will pass through the spring into the rivet on

the clip. Adjust the screw M4x50 to make the flanges close to the ceiling and tighten the screw. Repeat the same steps on the other side. (Fig. 8.4)

5. Put the LED reflector strip back and fix it with the screws and washers at both ends. (Fig. 8.5)
6. Attach the lens back to the housing. (Fig. 8.6)

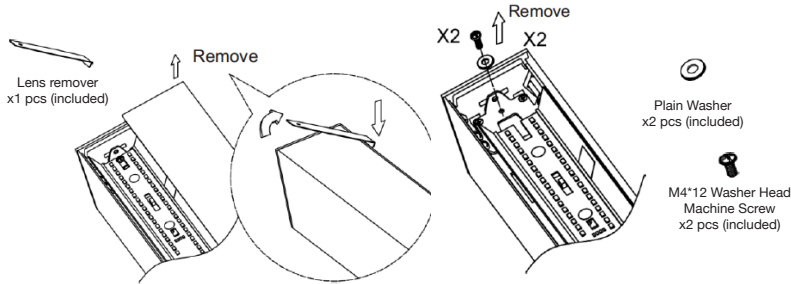

Fig. 8.1

	2ft	4ft	8ft
L	24.57" (624 mm)	48" (1219 mm)	95.04" (2414 mm)
W	3.27" (83 mm)		

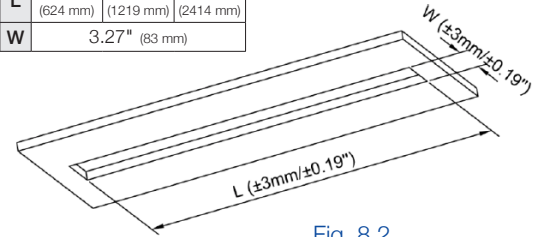

Fig. 8.2

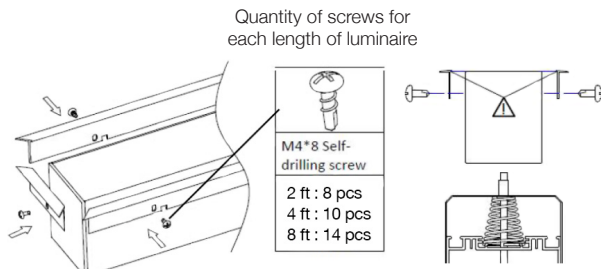

Fig. 8.3

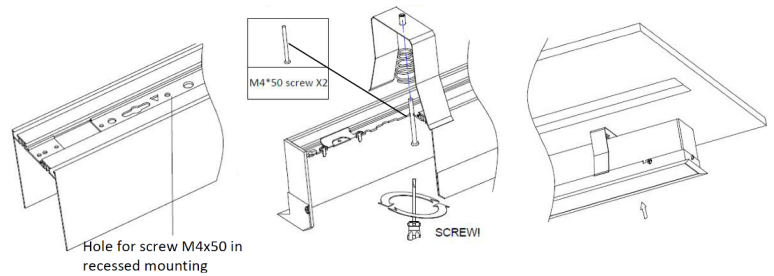

Fig. 8.4

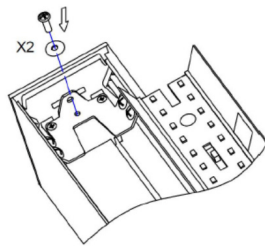

Fig. 8.5



Fig. 8.6

MUD-IN RECESSED MOUNT

(FOR INSTALLATION WITH DIRECT LUMINAIRES)

1. Remove lens and LED reflector strip. (Fig. 9.1)
2. Cut a rectangular hole on the mounting surface. (Fig. 9.2)
3. Install the mud-in bars to the housing with the M4x8 self-drilling screws that are provided in the kit. The flanges need to be 3.5 mm/0.137 inches lower than the surface of

the lens, this 3.5 mm/0.137 inch distance is for the thickness of the mud-in and painting. (Fig. 9.3)

4. Use the hardware in the kit to fix the luminaires with flanges to the ceiling, the screws will need to be evenly spaced. (Fig. 9.4)
5. Apply the desired material to cover the flange. (Fig. 9.5)

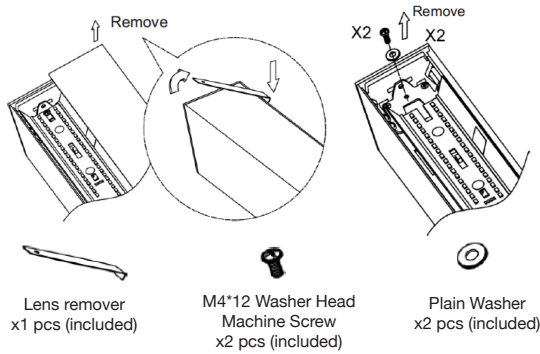

Fig. 9.1

	2ft	4ft	8ft
L	24.57" (624 mm)	48" (1219 mm)	95.04" (2414 mm)
W	3.27" (83 mm)		

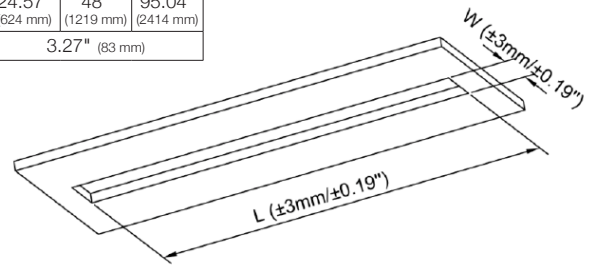

Fig. 9.2

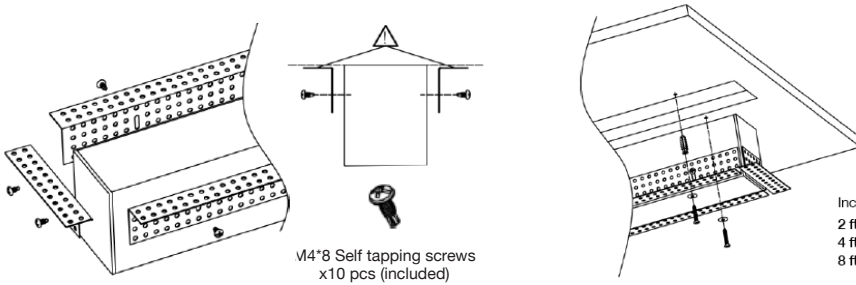

Fig. 9.3

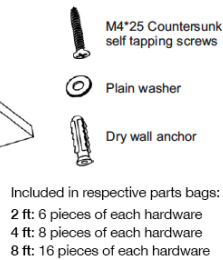

Fig. 9.4

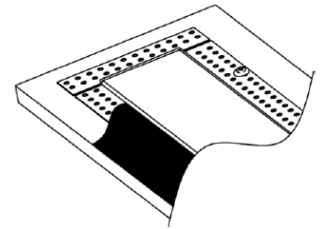
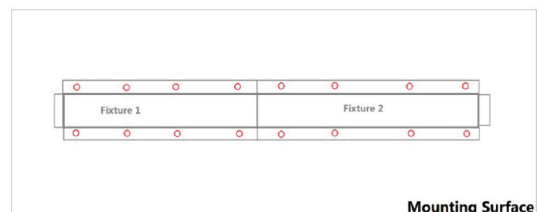
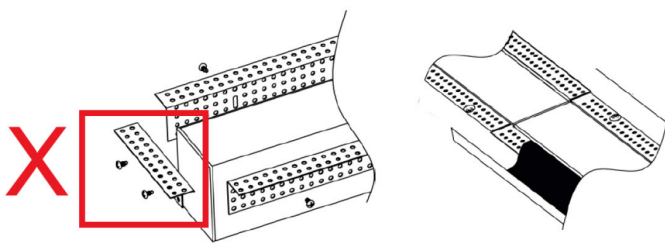

Fig. 9.5

NOTE: For continuous row mounting, install connection kits and screws to connect luminaires as per the section "CONTINUOUS ROW MOUNT AND CORNER CONNECTORS" in the included installation instructions. Then follow the Mud-In Recessed Kit instructions to complete. Do not install the shorter end pieces between every 2 luminaires.

Install all 8pcs of screws for each 4ft fixture.
The minimum mounting points required for every 2 or more fixtures are as below:

Qty of Fixtures in a Row	Min. Required Mounting Points
2	16
4	32
6	48



○ screw
□ fixture and mud-in mounting kit

Bottom View

Mounting Points for Suspended Configurations

NOTE: Blue circles on diagrams represent mounting points. Shaded grey areas represent Connectors.

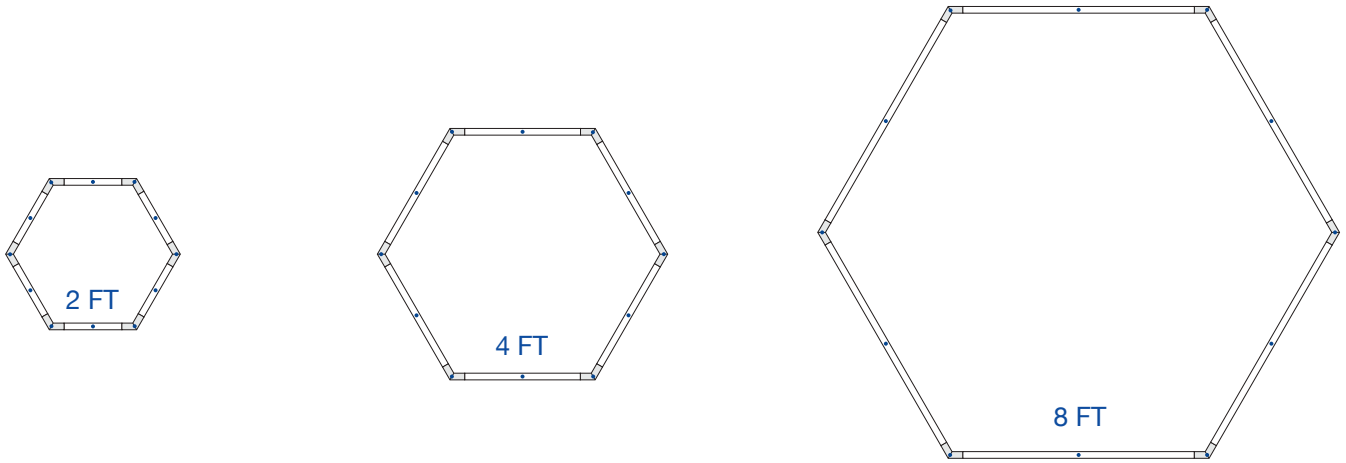

HEXAGONAL CONFIGURATION		
AL2	AL4	AL8
Parts Required for Configuration: 12 x Connector Kit (AL-C-KIT) 6 x Suspension Kit (AL-S-KIT) 6 x 120° Connector (AL-120-CON)	Parts Required for Configuration: 12 x Connector Kit (AL-C-KIT) 6 x Suspension Kit (AL-S-KIT) 6 x 120° Connector (AL-120-CON)	Parts Required for Configuration: 12 x Connector Kit (AL-C-KIT) 6 x Suspension Kit (AL-S-KIT) 6 x 120° Connector (AL-120-CON)
Suspension Points: 6 x suspension points on fixtures 6 x suspension points on connectors	Suspension Points: 6 x suspension points on fixtures 6 x suspension points on connectors	Suspension Points: 6 x suspension points on fixtures 6 x suspension points on connectors

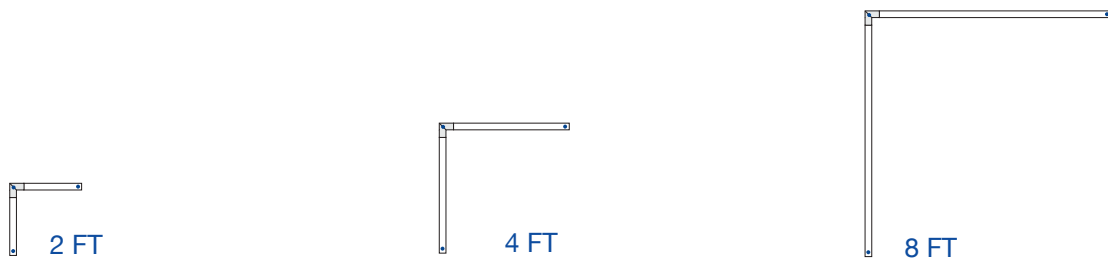

L CONFIGURATION		
AL2	AL4	AL8
Parts Required for Configuration: 2 x Connector Kit (AL-C-KIT) 2 x Suspension Kit (AL-S-KIT) 1 x 90° Connector (AL-90-CON)	Parts Required for Configuration: 2 x Connector Kit (AL-C-KIT) 2 x Suspension Kit (AL-S-KIT) 1 x 90° Connector (AL-90-CON)	Parts Required for Configuration: 2 x Connector Kit (AL-C-KIT) 2 x Suspension Kit (AL-S-KIT) 1 x 90° Connector (AL-90-CON)
Suspension Points: 2 x suspension points on fixtures 1 x suspension point on connector	Suspension Points: 2 x suspension points on fixtures 1 x suspension point on connector	Suspension Points: 2 x suspension points on fixtures 1 x suspension point on connector

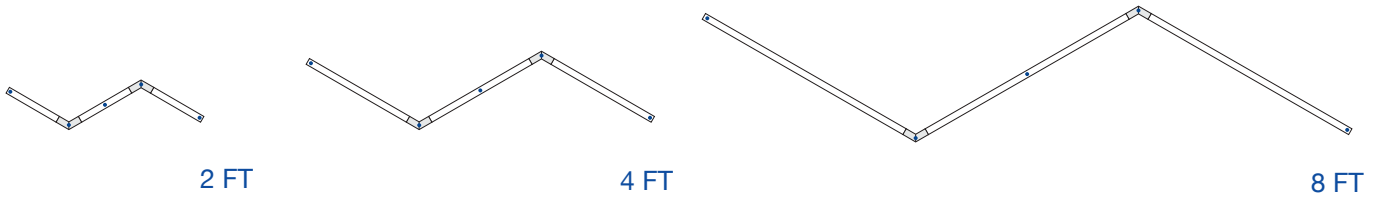

FLASH CONFIGURATION		
AL2	AL4	AL8
Parts Required for Configuration: 4 x Connector Kit (AL-C-KIT) 3 x Suspension Kit (AL-S-KIT) 2 x 120° Connector (AL-120-CON)	Parts Required for Configuration: 4 x Connector Kit (AL-C-KIT) 3 x Suspension Kit (AL-S-KIT) 2 x 120° Connector (AL-120-CON)	Parts Required for Configuration: 4 x Connector Kit (AL-C-KIT) 3 x Suspension Kit (AL-S-KIT) 2 x 120° Connector (AL-120-CON)
Suspension Points: 3 x suspension points on fixtures 2 x suspension points on connectors	Suspension Points: 3 x suspension points on fixtures 2 x suspension points on connectors	Suspension Points: 3 x suspension points on fixtures 2 x suspension points on connectors

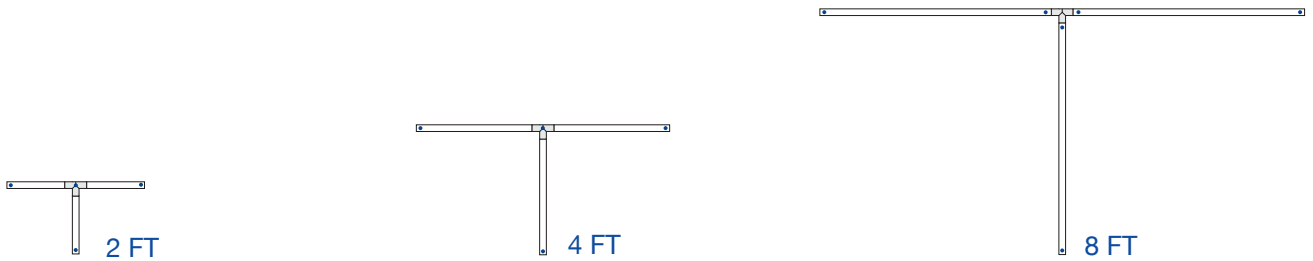

T CONFIGURATION		
AL2	AL4	AL8
Parts Required for Configuration: 3 x Connector Kit (AL-C-KIT) 2 x Suspension Kit (AL-S-KIT) 1 x T Connector (AL-T-CON)	Parts Required for Configuration: 3 x Connector Kit (AL-C-KIT) 2 x Suspension Kit (AL-S-KIT) 1 x T Connector (AL-T-CON)	Parts Required for Configuration: 3 x Connector Kit (AL-C-KIT) 3 x Suspension Kit (AL-S-KIT) 1 x T Connector (AL-T-CON)
Suspension Points: 3 x suspension points on fixtures 1 x suspension point on connector	Suspension Points: 3 x suspension points on fixtures 1 x suspension point on connector	Suspension Points: 6 x suspension points on fixtures 0 x suspension points on connector

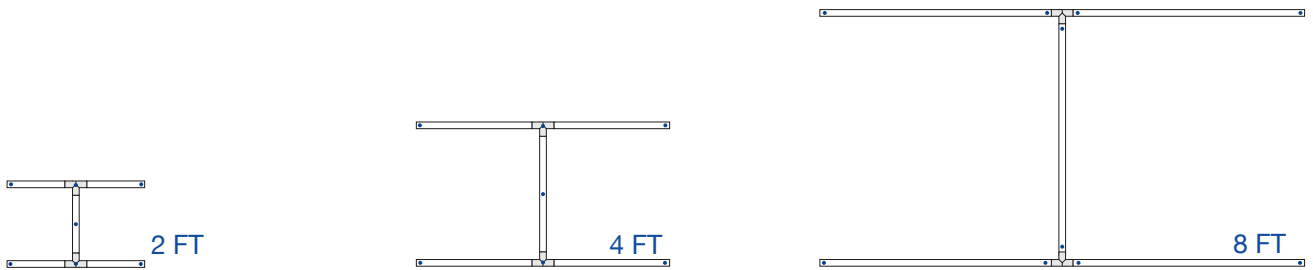

H CONFIGURATION		
AL2	AL4	AL8
Parts Required for Configuration: 6 x Connector Kit (AL-C-KIT) 4 x Suspension Kit (AL-S-KIT) 2 x T Connector (AL-T-CON)	Parts Required for Configuration: 6 x Connector Kit (AL-C-KIT) 4 x Suspension Kit (AL-S-KIT) 2 x T Connector (AL-T-CON)	Parts Required for Configuration: 6 x Connector Kit (AL-C-KIT) 5 x Suspension Kit (AL-S-KIT) 2 x T Connector (AL-T-CON)
Suspension Points: 5 x suspension points on fixtures 2 x suspension points on connectors	Suspension Points: 5 x suspension points on fixtures 2 x suspension points on connectors	Suspension Points: 10 x suspension points on fixtures 0 x suspension points on connectors

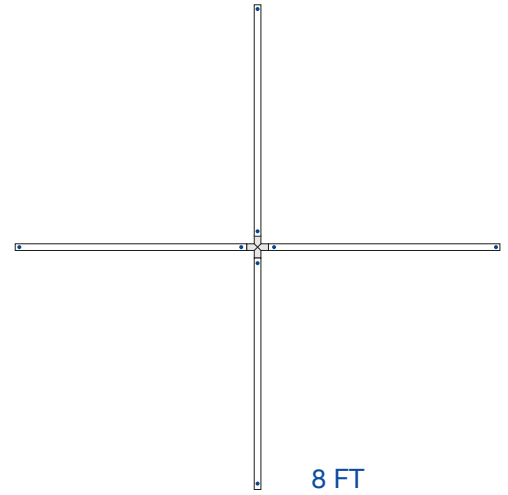
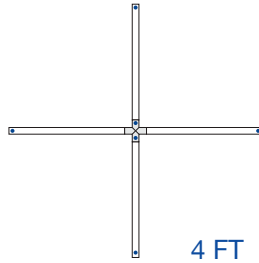
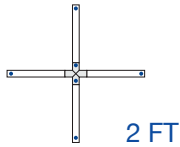

CROSS CONFIGURATION		
AL2	AL4	AL8
Parts Required for Configuration: 4 x Connector Kit (AL-C-KIT) 3 x Suspension Kit (AL-S-KIT) 1 x X Connector (AL-X-CON)	Parts Required for Configuration: 4 x Connector Kit (AL-C-KIT) 3 x Suspension Kit (AL-S-KIT) 1 x X Connector (AL-X-CON)	Parts Required for Configuration: 4 x Connector Kit (AL-C-KIT) 4 x Suspension Kit (AL-S-KIT) 1 x X Connector (AL-X-CON)
Suspension Points: 4 x suspension points on fixtures 2 x suspension points on connectors	Suspension Points: 4 x suspension points on fixtures 2 x suspension points on connectors	Suspension Points: 8 x suspension points on fixtures 0 x suspension points on connectors

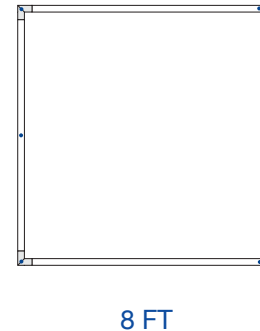
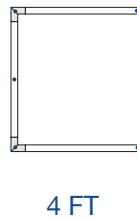
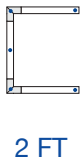

U CONFIGURATION		
AL2	AL4	AL8
Parts Required for Configuration: 4 x Connector Kit (AL-C-KIT) 3 x Suspension Kit (AL-S-KIT) 2 x 90° Connector (AL-90-CON)	Parts Required for Configuration: 4 x Connector Kit (AL-C-KIT) 3 x Suspension Kit (AL-S-KIT) 2 x 90° Connector (AL-90-CON)	Parts Required for Configuration: 4 x Connector Kit (AL-C-KIT) 3 x Suspension Kit (AL-S-KIT) 2 x 90° Connector (AL-90-CON)
Suspension Points: 3 x suspension points on fixtures 2 x suspension points on connectors	Suspension Points: 3 x suspension points on fixtures 2 x suspension points on connectors	Suspension Points: 3 x suspension points on fixtures 2 x suspension points on connectors



2 FT

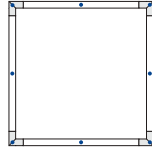

4 FT

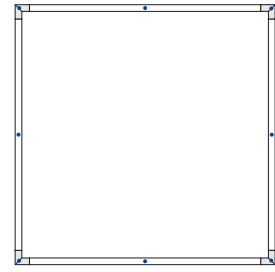

8 FT

SQUARE CONFIGURATION

AL2	AL4	AL8
Parts Required for Configuration: 8 x Connector Kit (AL-C-KIT) 4 x Suspension Kit (AL-S-KIT) 4 x 90° Connector (AL-90-CON)	Parts Required for Configuration: 8 x Connector Kit (AL-C-KIT) 4 x Suspension Kit (AL-S-KIT) 4 x 90° Connector (AL-90-CON)	Parts Required for Configuration: 8 x Connector Kit (AL-C-KIT) 4 x Suspension Kit (AL-S-KIT) 4 x 90° Connector (AL-90-CON)
Suspension Points: 4 x suspension points on fixtures 4 x suspension points on connectors	Suspension Points: 4 x suspension points on fixtures 4 x suspension points on connectors	Suspension Points: 4 x suspension points on fixtures 4 x suspension points on connectors